

28th Annual Conference
July 29-30, 1994
Wilson World Hotel
Mall of Memphis
2715 Cherry Road
Memphis, Tennessee

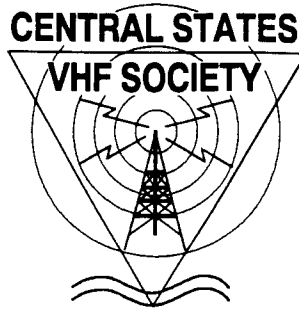

Dave Meier N4MW	President
Joel Harrison WB5IGF	Vice President
Larry Hazelwood W5NZS	Secretary
Charlie Chennault WA5YOU	Treasurer

Society members and other interested VHF operators,

It's time to collect dues for 1994 Society membership and to register for the 1994 conference. As you might well imagine, there is a lot of work that goes into a conference. We have been busy preparing for your arrival.

Ordinarily this mailing would contain the preamplifier and antenna measurement results from last year's conference. Instead, they will be included in the conference proceeding which will be provided to all attendees. Since the ARRL publishes the proceedings, they will be available to all those who cannot attend the conference.

The first mailing many of you received in February contained a membership roster. Unfortunately, some of the longer callsigns got clipped in formatting the printout. Let me assure you that all the callsigns are really complete in the database.

Please take time to read through the conference registration form instructions. Even if you cannot attend the conference, please consider paying your Society dues. This will keep you on the mailing list and help defray expenses. Whether or not you can attend the conference, please check and correct your address, phone numbers and grid data. Also please indicate which bands you operate. This data is important as an indicator of interest in the VHF and higher bands.

Al Ward WB5LUA is handling the preamplifier measurements again this year. He indicates a desire to change the emphasis from a competition to more of a workshop. So you guys out there who may have been holding back on bringing your preamp progeny for fear of embarrassment need not be concerned. Build 'em and bring 'em.

Antenna measurements will once again be handled by the team of Marc Thorson WBØTEM and Kent Britain WA5VJB. Prizes are being rounded up by Gary Gerber KBØHH with assistance from Paul Wilson W4HHK. Joel Harrison WB5IGF has arranged the technical program and assembled the proceedings. Cissy Meier N4ZRW has arranged the family programs described on the other side of this letter.

Wilson World is located on the southern loop of I-240. Take the Perkins Road exit south to American Way. Take a right turn on to American Way at the Mall of Memphis. Wilson World is immediately west of the mall.

If you are driving in from the north on I-55, you might consider transitioning to I-40 in the West Memphis, Arkansas area. This will bring you across the "new" bridge and will provide the best view of the Pyramid, harbor and downtown areas. I-55 crosses the river further south. Either way you choose, follow the signs toward Jackson, Mississippi, but watch out for the transition to I-240.

Coming from the west on I-40 just follow the signs toward Jackson, Mississippi, then transition to the south loop of I-240 on the south side of Memphis. Continue east to the Perkins Road Exit.

Coming from the south on I-55, transition to I-240 eastbound. Continue east to the Perkins Road Exit.

Coming from the east on I-40, take I-240 south toward Jackson, Mississippi and exit at Perkins Road.

For those of you flying in commercially, Wilson World provides an airport shuttle service. If you are flying yourself, you can use Memphis International (MEM), but the closest reliever airport is Olive Branch, Mississippi (OLV). Other area fields are DeWitt Spain (MØ1) and Charles Baker (2M8). Give me a call at 901-382-4919 if you need special pick-up arrangements.

Dave

Dave Meier N4MW
CSVHF Society 1994 President

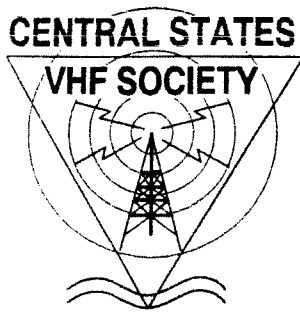

Family Programs

Dear Family Members,

Welcome to Memphis! I would like to invite you to participate in the planned family activities.

Friday, July 29 will be a busy day:

- Beginning Friday morning we will go on a guided bus tour of Memphis that will include the downtown area, the Pyramid and the Mississippi River with a stop at the Peabody Hotel to witness the "March of the Ducks". At the end of the Memphis tour we will have a barbeque and spaghetti buffet at the Public Eye Restaurant in Overton Square. We will then board the bus for a deluxe tour of Graceland, the home of Elvis Presley. In addition to the Graceland Mansion, we will visit the Meditation Garden, Elvis' jet planes and cars. The cost of all this, including transportation and lunch, is \$34.00.
- On Friday Evening we will go on a Riverboat dinner cruise. Dinner for the evening will be the Captain's Prime Rib. A cash bar will be available. A Dixieland band will be aboard to provide entertainment. Dress is casual for the cruise. Bus transportation will be provided. The cost for the dinner cruise is \$29.00.

On Saturday morning the bus will be available for transportation to and from the locations listed below. Fees will not be collected in advance for these tour sites.

- The Pink Palace Museum, featuring the cultural and natural history of the Mid-South region. There is also a planetarium inside the museum with a show at 11:00 am.

Museum admission	Adults \$5.50	Children \$3.50
Planetarium admission	Adults \$3.00	Children \$2.00
- The Ornamental Metal Museum, located on the river bluff, is the only museum in the U.S. dedicated to preserving the art and craftsmanship of metalworking.

Admission	Adults \$2.00	Children \$1.00
-----------	---------------	-----------------
- Mud Island features a five block long scale model of the Mississippi River. The island is also the home of the Memphis Belle B-17 bomber of WW2 fame. Also on the island is an 18 gallery Mississippi River Museum featuring river life, legends, models and folklore.

Admission (without museum)	Adults \$2.00	Children \$1.00
Admission (including museum)	Adults \$6.00	Children \$4.00
- Victorian Village is a historic district featuring a number of homes dating from the mid-1800s.
 - ⇒ The Mallory-Neely House is an Italian Villa Mansion built in the mid 1850s.

Admission	Adults \$4.00	Children \$3.00
-----------	---------------	-----------------
 - ⇒ The Magevney House is a diminutive clapboard house built in the 1830s.

On Saturday afternoon you can proceed at your own pace. This would be a good time to visit the Mall of Memphis for some shopping. Or, if you need to unwind, relax at the pool. For those who need something in between, there will be a Christmas-in-July "Make it and take it" crafts demonstration. The fee for this demonstration is approximately \$4.00.

Babysitting will be provided by Annie's Nannies on Friday and Saturday between 9:00 am and 10:00 pm. There will be a special Children's Banquet on Saturday night. Snacks will be provided; however, parents are responsible for providing meals at other times.

I will meet with the teenagers on Thursday evening to help co-ordinate their activities. Remember that these are unsupervised activities. Teens are welcome on any of the tours.

I look forward to seeing all of you in July. If you have any questions, please call me at 901-382-4844.

Cissy Meier N4ZRW

Family Programs Chairperson

PS

There will be a drawing for ladies prizes during the banquet on Saturday night. Any donation to the prize table would be greatly appreciated.

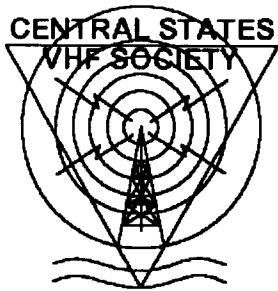

28th Annual Central States VHF Society Conference
July 29-30, 1994 Memphis, TN
Registration Form

Tom Ring WA2PHW
5917 France S
Edina, MN 55410

(Indicate corrections)

Phone night 612/922-1317 day Grid EN34
Spouse Call

ARRL member? YES NO

Society records indicate your dues were paid through 12/31/92.

Society dues (94/95, each attendee must pay dues to attend conference) @ \$ 5.00

Conference fee (each attendee, includes one copy of the proceedings) @ \$28.00

Saturday banquet (each attendee) @ \$25.00

Extra proceedings (each copy) @ \$12.00

Conference Sub-Total \$

Do you plan to bring:

- fleamarket items? YES NO
preamps? 50 144 222 432 902 1296 2304 3456 5760 10368 24GHz
antennae? 50 144 222 432 902 1296 2304 3456 5760 10368 24GHz

Do you operate: (check box for all applicable bands)

- CW/ SSB? 50 144 222 432 902 1296 2304 3456 5760 10368 24GHz
EME? 50 144 222 432 902 1296 2304 3456 5760 10368
Satellite? K-15m A-10m V-2m U-70cm L-23cm S-13cm G-5cm X-3cm

Family Programs

Names of family members who will be attending

Child care needed for (list names/ages)

Family programs fee (per family) @ \$ 5.00

Friday: Memphis-Graceland tour (incl. transportation & lunch, each) @ \$34.00

Riverboat dinner cruise (include. transportation, evening, each) @ \$29 00

Saturday: Tour (charges collected during tour, select one only) Museum or Victorian Homes

Christmas-in-July "Make-it & Take it" (\$4 each, please indicate interest) YES NO

Kid's banquet (evening, 3 to 12-year olds, each) @ \$ 5.00

Can you provide a women's banquet prize(s)? YES NO Family Sub-Total \$

Total Enclosed (Conference Sub-Total + Family Sub-Total) \$

Make checks payable to: Central States VHF Society
Please remit with form by July 10, 1994 to: Dave Meier, 3205 Covington Pike, Memphis, TN 38128-5017

Registration Form Instructions

Name and address according to the CSVHF database has been preprinted on your form. Please check your name and indicate any desired changes. If you use a nickname or prefer another specific variation, be sure to indicate your preference, because *your conference name tag will be printed from the database as you indicate*. If you are reading this, your address is apparently sufficient, but you can of course modify it if desired. To simplify this mailing and save postage, only one form is provided even if your household more than one CSVHF member. To indicate more than one member, just write in the names and calls in the space provided below and indicate the appropriate extended amounts for dues or other fees as applicable.

If the database contains your **phone number**, it will appear preprinted on your form. Please correct or fill in missing data if you can accept phone calls and wish your numbers to be listed in the roster.

Your (probable, based on zip code) **grid** will also be preprinted if known. If it is incorrect or incomplete, write in the correct grid (six digit if available). The grid data will be used for various member services, so please make sure it is correct.

Indicate the name and call of your **spouse**, if desired. This does not indicate conference registration, we are just trying to collect the data for reference purposes. Of course, spouses are welcome to participate in the conference by registering as described above if desired.

Please indicate if you are an **ARRL** member or not. This is used to develop necessary statistics to be eligible for ARRL membership services.

If **dues paid** data is available a "paid through" will be printed on your form above the Society dues entry line. If

your dues are prepaid through 1994, the word **PAID** will be printed in the blank space. Otherwise write in the appropriate amount to be paid. *Please pay your dues even if you cannot attend the conference*. This assures you of continued mailings and indicates your continued desire to participate in the Society.

Write in the appropriate extended amounts for the **conference fee, banquet and extra proceedings**. Write in the Conference sub-total (dues+fee+banquet+extra proceedings). Normally this will total \$58 for a single registrant.

To give us an idea what to expect, please indicate if you are bringing **fleamarket items** by checking a box. Also indicate how many **preamps or antennae** you are bringing to be measured by indicating numbers in the band boxes. This information will be provided to the appropriate assistants to give them a heads-up on what to expect.

Please check off all bands you operate **SSB/CW, EME or Satellite**. This information will be used during the conference and will be made available to all.

Please list the **names of family members** who will be participating in family events (child care, teens, tour participants, etc.). Please list separately the names and ages of children requiring **child care service**. Please write in the \$5 family programs fee if applicable. Also write in the extended amount for those family members who desire to take the **tour or cruise** on Friday. Please check or indicate the number of members desiring to take either of the **Saturday tours**. Note that these are conducted simultaneously, so each family member can only choose one tour. Indicate the extended **Kid's banquet** amount in the blank provided. Write in the Family Sub-Total in the blank provided.

Add the Conference and Family Sub-Totals and write the **Total Enclosed** amount in the blank provided. Make your check out for that amount and forward soon.

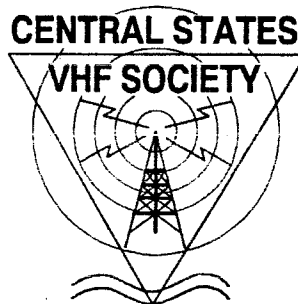

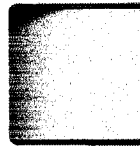

RESERVATION REQUEST

Number of Rooms _____ Number of Adults _____ Number of Children _____ Crib _____
 Arrival date _____ Departure date _____
 Name _____
 Address _____
 City _____ State _____ Zip _____
 Phone: _____ Business _____ Home _____
 Credit card type _____ # _____ Exp. date _____
 Special Request: _____

Special Requests on availability basis only.

***Advance deposit of first night's room rent is required without credit card guarantee.**

Please Note:
 If a room is not available at the rate requested, reservation will be made at the next available rate. Reservations will not be held after 4 p.m. unless guaranteed by advance payment or credit card number. Requests received after deadline date are subject to availability. (Deadline date shown in bottom right corner.) Circumstances permitting, we will honor special room requests.

CS VHF Society

Name of Group

Please Note
Check-in after 2 P.M.
Check-out 12 Noon

Reservation must be received by
 7-14-94

*Deposit refunded with 72 hour cancellation notice.
 (901) 366-5225
 1-800-872-8366

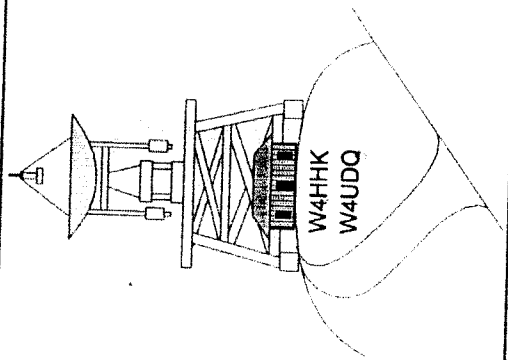

*You are invited to an open house
1:00 pm Sunday, July 31, 1994
Collierville, Tennessee*

The Wilsons, Paul W4HHK and dB W4UDQ

Please RSVP by filling out this form and returning it along with your conference reservation.

Name _____ Call _____ Number of persons attending _____

CENTRAL STATES
VHF SOCIETY



Central States VHF Society

Dave Meier N4MW
3205 Covington Pike
Memphis, TN 38128-5017

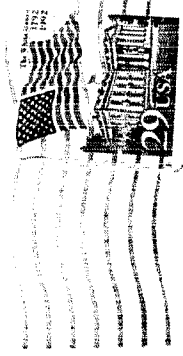

Tom Ring WA2PHW
5917 France S
Edina, MN 55410

55410 2749 13

MEMPHIS 381282007 1494 06/06/95
NEVER SENDER OF NEW ADDRESS
NEED MAIL SERVICES OR
NEW KENT VA 22949-2904

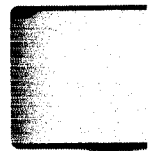
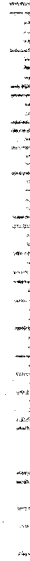

Registration Form Instructions

Name and address according to the CSVHF database has been preprinted on your form. Please check your name and indicate any desired changes. If you use a nickname or prefer another specific variation, be sure to indicate your preference, because *your conference name tag will be printed from the database as you indicate*. If you are reading this, your address is apparently sufficient, but you can of course modify it if desired. To simplify this mailing and save postage, only one form is provided even if your household more than one CSVHF member. To indicate more than one member, just write in the names and calls in the space provided below and indicate the appropriate extended amounts for dues or other fees as applicable.

If the database contains your **phone number**, it will appear preprinted on your form. Please correct or fill in missing data if you can accept phone calls and wish your numbers to be listed in the roster.

Your (probable, based on zip code) **grid** will also be preprinted if known. If it is incorrect or incomplete, write in the correct grid (six digit if available). The grid data will be used for various member services, so please make sure it is correct.

Indicate the name and call of your **spouse**, if desired. This does not indicate conference registration, we are just trying to collect the data for reference purposes. Of course, spouses are welcome to participate in the conference by registering as described above if desired.

Please indicate if you are an **ARRL** member or not. This is used to develop necessary statistics to be eligible for ARRL membership services.

If **dues paid** data is available a "paid through" will be printed on your form above the Society dues entry line. If

your dues are prepaid through 1994, the word **PAID** will be printed in the blank space. Otherwise write in the appropriate amount to be paid. *Please pay your dues even if you cannot attend the conference*. This assures you of continued mailings and indicates your continued desire to participate in the Society.

Write in the appropriate extended amounts for the **conference fee, banquet and extra proceedings**. Write in the Conference sub-total (dues+fee+banquet+extra proceedings). Normally this will total \$58 for a single registrant.

To give us an idea what to expect, please indicate if you are bringing **fleamarket items** by checking a box. Also indicate how many **preamps or antennae** you are bringing to be measured by indicating numbers in the band boxes. This information will be provided to the appropriate assistants to give them a heads-up on what to expect.

Please check off all bands you operate **SSB/CW, EME or Satellite**. This information will be used during the conference and will be made available to all.

Please list the **names of family members** who will be participating in family events (child care, teens, tour participants, etc.). Please list separately the names and ages of children requiring **child care service**. Please write in the \$5 family programs fee if applicable. Also write in the extended amount for those family members who desire to take the **tour or cruise** on Friday. Please check or indicate the number of members desiring to take either of the **Saturday tours**. Note that these are conducted simultaneously, so each family member can only choose one tour. Indicate the extended **Kid's banquet** amount in the blank provided. Write in the Family Sub-Total in the blank provided.

Add the Conference and Family Sub-Totals and write the Total Enclosed amount in the blank provided. Make your check out for that amount and forward soon.

